



Coriolis Mass Flow Meter

for liquids and gas



measuring
•
monitoring
•
analysing

TM



- Measuring range:
0-0.8 kg/h... 0-65 000 kg/h water
- Accuracy: ± 0.1 of reading
 \pm zero-point stability (liquids)
- p_{\max} : 40 bar; t_{\max} : -40 ... +260 °C
- Connection: 1/4" NPT, 1/2" NPT female, flange
DN10 ... DN100, 1/2" ... 4" class 150/300/600
- Material: stainless steel, Hastelloy, Monel,
nickel or tantalum
- Options: contacts, analogue output with HART®,
Profibus-PA® or Modbus RTU



SS

KOBOLD companies worldwide:

ARGENTINA, AUSTRALIA, AUSTRIA, BELGIUM, BULGARIA, CANADA, CHILE, CHINA, COLOMBIA, CZECHIA, EGYPT, FRANCE, GERMANY, GREAT BRITAIN, HUNGARY, INDIA, INDONESIA, ITALY, MALAYSIA, MEXICO, NETHERLANDS, PERU, POLAND, REPUBLIC OF KOREA, ROMANIA, SINGAPORE, SPAIN, SWITZERLAND, TAIWAN, THAILAND, TUNISIA, TURKEY, USA, VIETNAM

KOBOLD Messring GmbH
Nordring 22-24
D-65719 Hofheim/Ts.
Head Office:
+49(0)6192 299-0
+49(0)6192 23398
info.de@kobold.com
www.kobold.com



Description

The TM Series Mass Flow Meter utilizes the Coriolis principle of operation to measure mass flow. Density and temperature are simultaneously monitored and volumetric flow is additionally calculated with these parameters. The TM Series is available with a direct mounted transmitter or in a remote mounted configuration.

The TM Series can be used to meter nearly all liquid or gaseous media. Available in a variety of end connections, the TM can be used in many applications. The TM Series is also used for precise dosing applications.

The TM Series has following unique features:

- Superior accuracy
- Industry's widest selection of wetted materials
- Thick pipe wall construction for ultrahigh pressure capability
- Superior heating jacket technology

Application Areas

- Chemical industry
- Petrochemical industry
- Food industry
- Oil industry
- Gas industry

Technical Details

Sensor

Measuring principle:	Coriolis
Measurable media:	liquids and gases
Materials:	
flow tubes, splitter, flanges:	st. steel 1.4404 (316 L)/ 1.4571 (316 Ti), Hastelloy C-22/B-2, Monel, nickel, tantalum
housing:	stainless steel 1.4301 (304) up to TM025 st 37.2/ 1.4301 (304) from TM050
Process connections:	acc. to EN 1092, ASME B16.5, DIN 2512, NPT, special connections on request
Nominal pressure:	PN 40, ASME CI 150/300/600 higher pressures on request max. 900 bar
Process temperature:	-40 ... +260 °C
Ambient temperature:	-40 ... +100 °C (remote version)
Protection:	IP 66/68 (EN60529)

Certificates and approvals

explosion protection	sensor circuits: intrinsically safe DMT 01 ATEX E 149 X Ⓔ II ½ G EEx ia IIC T6-T2 (approval for zone 0 inside flow tubes available)
CE-marking:	pressure equipment directive 97/23/EG

Transmitter UMC3

Material

housing:	aluminium (painted)
display cover:	safety class
Mounting:	integrated or remote mounted (junction box or plug-in connector)
Power supply:	19 - 36 V _{DC} , 24 V _{AC} +/- 20%, 90 - 265 V _{AC}
Outputs:	galvanically isolated
Current:	2 x 0(4) - 20 mA
Binary 1:	active, potential free 24 V _{DC} , max. 200 mA passive, optocoupler, U _i = 30 V, I _i = 200 mA, P _i = 3 W
Frequency:	1 KHz
Binary 2:	passive, optocoupler, U _i = 30 V, I _i = 200 mA, P _i = 3 W
Status:	passive, optocoupler, U _i = 30 V, I _i = 200 mA, P _i = 3 W

**Technical Details** (Continuation)

Input binary:	counter reset
Ambient temperature:	-20 ... +60 °C (standard) -20 ... +80 °C (remote mounted transmitter with approval 5 and 6)
Protection:	IP 68 (EN60529)
Communication:	HART® Profibus-PA® Modbus RTU (RS 485)

Transmitter UMC4**Material**

housing:	aluminium (painted)
Mounting:	integrated or remote mounted (junction box or cable)
Power supply:	19 - 36 V _{DC} 24 V _{AC} + 5 % / -20 %, 50/60 Hz 90 - 265 V _{AC} , 50/60 Hz

Output signals

All signal outputs:	galvanically isolated
Analogue output:	2 x 4 - 20 mA passive current output 1: mass flow, volume flow, density, temperature (when using HART® protocol, output 1 is assigned to mass flow) current output 2: mass flow, volume flow, density, temperature

Pulse output	
Binary 1:	pulse duration, standard 50 ms, adjustable from 0.1 ... 2000 ms pulse/pause ratio 1:1 (if the set pulse duration is below limit) as frequency output: max. 1 KHz passive, optocoupler, U _{nom} : 24 V, U _i = 30 V, I _i = 60 mA, P _i = 1,8 W

Pulse value:	settable in decade increments of selected pulse unit (e. g. kg or m ³)
--------------	--

Status:	forward flow, reverse flow, Min./Max. flow rate, Min./Max. density, Min./Max. temperature, alarm, second pulse output (out of phase by 90°) passive, optocoupler, U _{nom} : 24 V, U _i = 30 V, I _i = 60 mA, P _i = 1,8 W
---------	--

Ambient temperature:	-20 ... +60 °C (standard) below 0 °C the readability of the LC-display is limited
----------------------	--

Protection:	IP 68 (EN60529)
Communication:	HART®

Accuracy

liquid:	±0.1 % of reading (±0.05 % special calibration) ±zero point stability
gas:	±0.5 % of reading ±zero point stability
density (liquid):	±0.005 g/cm ³ mit with density calibration ±0.003 g/cm ³ mit special density calibration
volume:	±0.2 % of reading ±zero point stability

Certifications and Approvals

Explosion protection:	BVS 05 ATEX E 021 X Increased safety EEx e (connection): ⊕ II (1)2G EEx de [ia] IIC / IIB T6-T3 Explosion proof EEx d (connection): ⊕ II (1)2G EEx d [ia] IIC / IIB T6-T3
-----------------------	---

UMC-4

BVS 10 ATEX E 110 X ⊕ II (1)2G Ex d [ia Ga] IIC T4-T3 Gb IEC-Ex

Signal output/ input:	intrinsically safe or not intrinsically safe NEPSI Approval Cert No. GYJ06477
-----------------------	--

CE-marking:	explosion protection directive 94/9/EG EMC-Directive 2004/108/EG
-------------	---

Electromagnetic compatibility:	EN 61000-6-3:2001 (emissions residential environments) EN 61000-6-2:1999 (immunity for industrial environments) EN 55011:1998+A1:1999 group 1, class B (radio interference) EN 61000-4-2 up to DIN EN 61000-4-6 EN 61000-4-8 EN 61000-4-11 EN 61000-4-29 EN 61326
--------------------------------	---



Measuring Ranges

		Massflow						Zero point stability (of range)	
		Min. measuring range		Max. measuring range		Nominal ($\Delta p = 1 \text{ bar}$)			
Model	Sensor	kg/h	[lbs/min]	kg/h	[lbs/min]	kg/h	[lbs/min]	kg/h	[lbs/min]
TM-S01	TM002-S	0.8	[0.0]	8	[0.3]	8	[0.3]	0.001	[0.000]
TM-S04	TM003-S	2	[0.1]	20	[0.7]	20	[0.7] ¹⁾	0.002	[0.000]
TM-S07	TM004-S	8	[0.3]	80	[2.9]	65	[2.4]	0.008	[0.000]
TM-S10	TM005-S	15	[0.6]	150	[5.5]	150	[5.5] ²⁾	0.015	[0.001]
TM-S13	TM006-S	20	[0.7]	200	[7.3]	127	[4.7]	0.02	[0.001]
TM-S19	TM008-S	35	[1.3]	350	[12.9]	350	[12.9]	0.035	[0.00]
TM-H22	TM008-H	40	[1.5]	350	[12.9]	350	[12.9]	0.035	[0.00]
TM-S25/TM-H25	TM010-S/H	120	[4.4]	1200	[44.1]	1200	[44.1] ³⁾	0.12	[0.00]
TM-S34/TM-H34	TM015-S/H	300	[11.0]	3000	[110.2]	3000	[110.2] ⁴⁾	0.3	[0.0]
TM-S40/TM-H40	TM020-S/H	600	[22.1]	6000	[220.5]	6000	[220.5] ⁵⁾	0.6	[0.0]
TM-S49/TM-H49	TM025-S/H	2000	[73.5]	20 000	[734.9]	14 500	[532.8]	2	[0.1]
TM-S55	TM050-S	4000	[147.0]	40 000	[1469.7]	36 000	[1322.8]	4	[0.1]
TM-H55	TM050-H	4000	[147.0]	35 000	[1286.0]	28 500	[1047.2]	3.5	[0.1]

¹⁾ ($\Delta p = 0.69 \text{ bar}$)

²⁾ ($\Delta p = 0.79 \text{ bar}$)

³⁾ ($\Delta p = 0.88 \text{ bar}$)

⁴⁾ ($\Delta p = 0.43 \text{ bar}$)

⁵⁾ ($\Delta p = 0.85 \text{ bar}$)

		Massflow							
TM-T23	TM008-T	40	[1.5]	350	[12.9]	325	[11.9]	0.035	[0.00]
TM-T28	TM010-T	120	[4.4]	1200	[44.1]	1130	[41.5]	0.12	[0.00]
TM-T37	TM015-T	400	[14.7]	3000	[110.2]	3000	[110.2] ¹⁾	0.3	[0.0]
TM-T43	TM020-T	700	[25.7]	6000	[220.5]	5200	[191.1]	0.6	[0.0]
TM-T46	TM025-T	2000	[73.5]	18 000	[661.4]	13 700	[503.4]	1.8	[0.1]
TM-T54	TM050-T	4000	[147.0]	30 000	[1102.3]	30 000	[1102.3]	3	[0.1]
TM-TXX	TM080-T	6000	[220.5]	65 000	[2388.3]	65 000	[2388.3] ²⁾	6.5	[0.2]

¹⁾ ($\Delta p = 0.57 \text{ bar}$)

²⁾ ($\Delta p = 0.68 \text{ bar}$)

Order Details Sensor (Example: TM-SS01 6010 0350 A0U 1000)

Model/ Material	Sensor/ Measuring range	Process connection ¹⁾ (Flange for TM-S/-H acc. to DIN EN1092-1 Form B1)	Installation length	Containment
TM-S= stainless steel	01 = TM002, 0-8 kg/h (min. 0-0.8 kg/h)	6010 = ¼" NPT female 6030 = ½" NPT female 301B = flange DN10 PN40 305B = flange DN15 PN40	0350 = 350 mm XXXX = special length	E = st. steel housing 1.4301 R = pressure resistant st. st. containment, screwed PN 16, max. 150°C W = pressure resistant st. st. containment, welded PN 16, max. 150°C
	04 = TM003, 0-20 kg/h (min. 0-2 kg/h)			
	07 = TM004, 0-80 kg/h (min. 0-8 kg/h)			
	10 = TM005, 0-150 kg/h (min. 0-15 kg/h)			
	13 = TM006, 0-200 kg/h (min. 0-20 kg/h)			
19 = TM008, 0-350 kg/h (min. 0-35 kg/h)				
TM-H= Hastelloy C-22	22 = TM008, 0-350 kg/h (min. 0-40 kg/h)			
TM-T= tantalum	23 = TM008, 0-350 kg/h (min. 0-40 kg/h)	305B = flange DN15 PN40 DIN EN 1092-1 form B2		
TM-S= stainless steel TM-H= Hastelloy C-22	25 = TM010, 0-1200 kg/h (min. 0-120 kg/h)	6030 = ½" NPT female 301B = flange DN10 PN40 305B = flange DN15 PN40 309B = flange DN25 PN40	0400 = 400 mm XXXX = special length	E = st. steel housing 1.4301 F = pressure resistant steel containment, screwed PN 16, max. 150°C K = pressure resistant steel containment, welded PN 16, max. 150°C
TM-T= tantalum	28 = TM010, 0-1200 kg/h (min. 0-120 kg/h)	305B = flange DN15 PN40 DIN EN 1092-1 form B2		
TM-S= stainless steel TM-H= Hastelloy C-22	34 = TM015, 0-3000 kg/h (min. 0-300 kg/h)	305B = flange DN15 PN40 309B = flange DN25 PN40 321B = flange DN50 PN40	0450 = 450 mm XXXX = special length	
	40 = TM020, 0-6000 kg/h (min. 0-600 kg/h)		0550 = 550 mm XXXX = special length	
TM-T= tantalum	37 = TM015, 0-3000 kg/h (min. 0-400 kg/h)	309B = flange DN25 PN40 DIN EN 1092-1 form B2	0450 = 450 mm XXXX = special length	
	43 = TM020, 0-6000 kg/h (min. 0-700 kg/h)			
TM-S= stainless steel TM-H= Hastelloy C-22	49 = TM025, 0-20000 kg/h (min. 0-2000 kg/h)	309B = flange DN25 PN40 321B = flange DN50 PN40	0650 = 650 mm XXXX = special length	
				TM-T= tantalum
TM-S= stainless steel TM-H= Hastelloy C-22	55 = TM050, 0-40000 kg/h (min. 0-4000 kg/h)	321B = flange DN50 PN40 331B = flange DN80 PN40 336B = flange DN100 PN40	0750 = 750 mm XXXX = special length	
				TM-T= tantalum
TM-T= tantalum	XX = TM080, 0-65000 kg/h (min. 0-6000 kg/h)	335B = flange DN100 PN16	0730 = 730 mm XXXX = special length	S = steel containment E = st. steel containment 1.4301

¹⁾ Other flange-form or ANSI-flange on request



Order Details Sensor (continued)

Connection for cooling / heating	Flow direction	Sensor/ Process temperature/ Thread junction box	Zulassungen	Certificate	Additional Options
0 = without Heating/ Cooling-element 1 = Heating-element with Ermeto EO12 2 = Heating-element with DN15 PN40, DIN EN 1092-1 form B1 3 = Heating-element with Flange 1/2" Class 150 RF ASME B16.5 4²⁾ = Heating-element with DN25 PN40, DIN EN 1092-1 form B1 5²⁾ = Heating-element with Flange 1" Class 150 RF ASME B16.5	U = from bottom to top O = from top to bottom L = from left to right R = from right to left	1 = integrated transmitter, -20...+100 °C 2 = integrated transmitter, -20...+150 °C 3¹⁾ = remote mounted transmitter, -40...+100 °C, M 20x1.5 4¹⁾ = remote mounted transmitter, -40...+180 °C, M 20x1.5 5¹⁾ = remote mounted transmitter, -40...+260 °C, M 20x1.5 6¹⁾ = remote mounted transmitter, -40...+100 °C, 1/2" NPT 7¹⁾ = remote mounted transmitter, -40...+180 °C, 1/2" NPT 8¹⁾ = remote mounted transmitter, -40...+260 °C, 1/2" NPT	0 = without A = Ex II 1/2G EEx ia IIC T6 - T2, FM/FMC CL I, DIV 1, GPS ABCD T B = NEPSI	0 = without 1 = Certificate of compliance with the order 2.1 2 = Test report 2.2 B = Inspection certificate 3.1 C = Inspection certificate 3.2	0 = without 1 = Density calibration, 3-points (only for range '25' or bigger) X = with (separate specification necessary)

¹⁾ Please order cable glands separately, see accessories (not for range code 01/04/07/10)

²⁾ Only for measuring range code 25...54 and xx (sensor TM010 und higher)







Necessary Details for Dimensioning the TM Instrument

- Medium
- Process temperature min./max.
- Ambient temperature min./max.
- Measuring range
- Operating pressure
- Viscosity
- Density

Order Details Transmitter UMC3 (Example: UMC3 - A01A00K)

Model	Sensor	Display / Interface board	Power supply	Output
UMC3-	A = integrated transmitter, 1/2" NPT B = integrated transmitter, M 20x1,5 C¹⁾ = remote mounted transmitter with terminal block, 1/2" NPT D¹⁾ = remote mounted transmitter with terminal block, M 20x1,5 E¹⁾ = remote mounted transmitter with plug-in connector, 1/2" NPT F¹⁾ = remote mounted transmitter with plug-in connector, M 20x1,5	0 = without 1 = integrated in transmitter housing, ambient temperature up to 60 °C 2²⁾ = remotable, separate board plus panel mounting adapter set	1 = 90 - 265 V _{AC} , 50 / 60 Hz 2 = 19 - 36 V _{DC} , 24 V _{AC} (± 20 %), 50 / 60 Hz	A = analogue output, 0(4) - 20 mA with/without HART®, pulse output passive U _m = 30 V _{DC} , status output passive U _m = 30 V _{DC} B³⁾ = analogue output 0 (4)-20 mA with/without HART®, pulse output active 24 V _{DC} , status output passive U _m = 30 V _{DC} D⁴⁾ = Profibus-PA® (EEx ia IIC), all analogue and binary outputs disabled F⁵⁾ = Modbus*RTU (RS 485) analogue output 0 (4)-20 mA

Order Details Transmitter (continued)

Approvals	Protection signal output
0 = without	0K = without
1 =  II(1)2G Eex de [ia] IIB / IIC T3-T6 for ambient temperature up to 60 °C	1K = EEx ia 2K = EEx e (not intrinsically safe)
2 =  II(1)2G Eex d [ia] IIB / IIC T3-T6 for ambient temperature up to 60 °C	
3 =  FM CL I, DIV 1, GPS ABCD, T* / FMC CL I, BPS CD, T* for ambient temperature up to 60 °C	
4 =  NEPSI for ambient temperature up to 60 °C	
5 =  II(1)2G Eex de [ia] IIB / IIC T3-T6 for ambient temperature up to 80 °C	
6 =  II(1)2G Eex de [ia] IIB / IIC T3-T6 for ambient temperature up to 80 °C	

- ¹⁾ - Incl. wall mounting bracket, pipe mounting bracket must be ordered separately, see accessories
- Connection cable (sensor to transmitter) and cable gland must be ordered separately, see accessories
- ²⁾ Connection cable must be ordered separately
- ³⁾ Signal output in EEx ia not possible
- ⁴⁾ Not available with approval 3 and 4
- ⁵⁾ Not available with approval 3, 4, 5, or 6 and not with signal output protection 2

Order Details Transmitter UMC4 (Example: UMC4 - B 1 1 A 0 0K)

Model	Mounting/ Thread power supply output	Display / Interface board	Power supply	Outputs
UMC4-	B = integrated transmitter/M20x1,5 D¹⁾ = remote mounted transmitter, terminal block mounted/M20x1,5 (specify cable length in clear text) E¹⁾ = remote mounted transmitter, transmitter with 5 m cable/M20x1,5	1 = integrated in transmitter housing, ambient temperature up to 60 °C	1 = 90 - 265 V _{AC} , 50/60 Hz 2 = 19 - 36 V _{DC} , 24 V _{AC} (± 20 %), 50/60 Hz	A = analogue output, 0 (4) - 20 mA with/without HART®, pulse output passive U _m = 30 V _{DC} , status output passive U _m = 30 V _{DC}

Order Details Transmitter (continued)

Approvals	Protection signal output
0 = without	0K = without
2 = II(1)2G Eex d [ia] IIB/IIC T3-T6 ambient temperature up to 60 °C	1K = EEx ia 2K = EEx e (not intrinsically safe)

- ¹⁾ - Incl. wall mounting bracket, pipe mounting bracket must be ordered separately (see accessories)
- Connection cable (sensor to transmitter) and cable gland must be ordered separately (see accessories)

Order Details Accessories (Example: TMK - BL KK 005)

Order number	Model	Version	Cable length / Application area
TMK-	BL = connection cable	KK = sensor-transmitter with connection cable SK = sensor-transmitter cable end 1: plug (Harting Han® R23) cable end 2: cable connect SS = plug connection on both sides (Harting Han® R23) UB = transmitter-interface board plug connection	Cable length 005 = 5 m 010 = 10 m 015 = 15 m 030 = 30 m 075 = 75 m 150 = 150 m 300 = 300 m XXX = special length
	V = cable gland set	AU = integrated transmitter GU = remote mounted transmitter	Application area NEM 20 = not Ex, M 20 x1,5 NENPT = not Ex, 1/2" NPT DEIAM 20 = EEx de - EEx ia, M 20 x1.5 DEIANPT = EEx de - EEx ia, 1/2" NPT DEEM 20 = EEx de - EEx e, M 20 x1.5 DEENPT = EEx de - EEx e, 1/2" NPT
TM-	ROHRMONT = accessory for 2" pipe mounting		



Dimensions

TM-UMC3

Model		Sensor		A		B							
						Integrated transmitter				Remote mounted transmitter			
						-40 ... +100 °C		-40 ... +150 °C		-40 ... +100 °C		-40 ... +150 °C	
mm	[inch]	mm	[inch]	mm	[inch]	mm	[inch]	mm	[inch]	mm	[inch]		
TM-x01...TM-x23	TM002... TM008	350	[13.8]	429	[16.9]	531	[20.9]	331	[13.0]	433	[17.0]	533	[21.0]
TM-x25 / TM-x28	TM010	400	[15.7]	482	[19.0]	584	[23.0]	384	[15.1]	486	[19.1]	586	[23.1]
TM-x34 / 37 / 43	TM015 / TM020	450	[17.7]	534	[21.0]	636	[25.0]	436	[17.2]	538	[21.2]	638	[25.1]
TM-x40	TM020 - S / - H	550	[21.7]	534	[21.0]	636	[25.0]	436	[17.2]	538	[21.2]	638	[25.1]
TM-x46 / TM-x49	TM025	650	[25.6]	584	[23.0]	686	[27.0]	486	[19.1]	588	[23.1]	688	[27.1]
TM-x54 / TM-x55	TM050	750	[29.5]	699	[27.5]	801	[31.5]	601	[23.7]	703	[27.7]	803	[31.6]
TM-T XX	TM080	730	[28.7]	629	[24.8]	731	[28.8]	531	[20.9]	633	[24.9]	733	[28.9]

TM-UMC3 (continued)

Model	Sensor	C		F		G	
mm	[inch]	mm	[inch]	mm	[inch]	mm	[inch]
TM-x01...TM-x23	TM002... TM008	125	[4.9]	42	[1.7]	94	[3.7]
TM-x25 / TM-x28	TM010	170	[6.7]	45	[1.8]	112	[4.4]
TM-x34 / 37 / 43	TM015 / TM020	215	[8.5]	52	[2.1]	132	[5.2]
TM-x40	TM020 - S / - H	215	[8.5]	52	[2.1]	132	[5.2]
TM-x46 / TM-x49	TM025	255	[10.0]	2	[2.4]	162	[6.4]
TM-x54 / TM-x55	TM050	378	[14.9]	102	[4.0]	272	[10.7]
TM-T XX	TM080	380	[15.0]	115	[4.5]	230	[9.1]

TM-UMC4

Model		Sensor		A		B							
						Integrated transmitter				Remote mounted transmitter			
						-40 ... +100 °C		-40 ... +150 °C		-40 ... +100 °C		-40 ... +180 °C	
mm	[inch]	mm	[inch]	mm	[inch]	mm	[inch]	mm	[inch]	mm	[inch]		
TM-x01...TM-x23	TM002... TM008	350	[13,8]	460	[18,1]	562	[22,1]	331	[13,0]	433	[17,0]	533	[21,0]
TM-x25 / TM-x28	TM010	400	[15,7]	513	[20,2]	615	[24,2]	384	[15,1]	486	[19,1]	586	[23,1]
TM-x34 / 37 / 43	TM015 / TM020	450	[17,7]	565	[22,2]	667	[26,3]	436	[17,2]	538	[21,2]	638	[25,1]
TM-x40	TM020 - S / - H	550	[21,7]	534	[21,0]	636	[25,0]	436	[17,2]	538	[21,2]	638	[25,1]
TM-x46 / TM-x49	TM025	650	[25,6]	615	[24,2]	717	[28,2]	486	[19,1]	588	[23,1]	688	[27,1]
TM-x54 / TM-x55	TM050	750	[29,5]	730	[28,7]	832	[32,8]	601	[23,7]	703	[27,7]	803	[31,6]
TM-T XX	TM080	730	[28,7]	788	[31,0]	890	[35,0]	659	[25,9]	761	[30,0]	861	[33,9]

TM-UMC4 (continued)

Model	Sensor	C		F		G	
mm	[inch]	mm	[inch]	mm	[inch]	mm	[inch]
TM-x01...TM-x23	TM002... TM008	125	[4,9]	42	[1,7]	94	[3,7]
TM-x25 / TM-x28	TM010	170	[6,7]	45	[1,8]	112	[4,4]
TM-x34 / 37 / 43	TM015 / TM020	215	[8,5]	52	[2,0]	132	[5,2]
TM-x40	TM020 - S / - H	215	[8,5]	52	[2,1]	132	[5,2]
TM-x46 / TM-x49	TM025	255	[10,0]	62	[2,4]	162	[6,4]
TM-x54 / TM-x55	TM050	378	[14,9]	102	[4,0]	272	[10,7]
TM-T XX	TM080	375	[14,8]	115	[4,5]	230	[9,1]



Integrated Transmitter

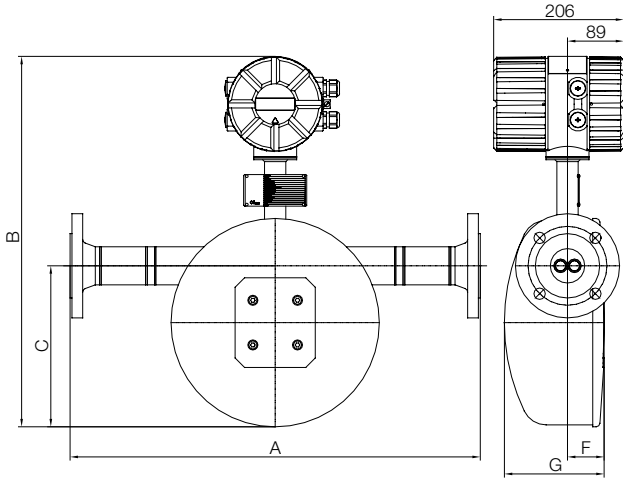

Remote Mounted Transmitter

